

TSL-7000Z

SLIT LAMP

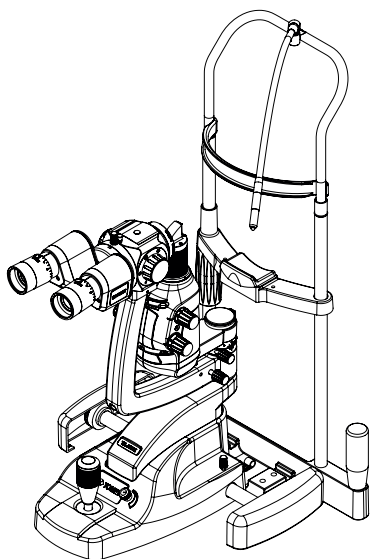

























OPERATOR MANUAL

Z Series



CONTENTS

1. INDICATIONS FOR USE	3
2. SAFETY.....	3
2.1 PHOTOTOXICITY	3
2.2 WARNINGS AND CAUTIONS	4
2.3 CONTRAINDICATION.....	5
3. CLEANING AND DISINFECTION INSTRUCTIONS.....	6
4. NAMES OF CONTROLS AND COMPONENTS	6
5. ASSEMBLY	8
5.1 TABLE TOP AND BASE ASSEMBLY PROCEDURE.....	8
5.2 ILLUMINATION TOWER ASSEMBLY PROCEDURE.....	9
5.3 CABLE ATTACHMENT PROCEDURE	10
5.4 FITTING APPLANATION TONOMETERS, T TYPE AND Z TYPES	11
6. INSTRUCTIONS FOR USE	12
6.1 SETTING THE BINOCULARS.....	12
6.2 PREPARING THE PATIENT AND USING THE SLIT LAMP	13
6.3 DESCRIPTION OF FILTERS, APERTURES AND MAGNIFICATIONS.....	14
7. ROUTINE MAINTENANCE	15
7.1 LED SYSTEMS.....	15
7.2 REGULARLY INSPECT THE DEVICE FOR DAMAGE OR DIRT.....	15
7.3 CLEANING THE ILLUMINATION PRISM	15
7.4 ELECTRICAL CONNECTIONS.....	15
7.5 OPTICS.....	15
7.6 AXLE AND MECHANICAL PARTS	15
8. WARRANTY	15
9. SPECIFICATIONS AND ELECTRICAL RATINGS.....	16
9.1 ELECTROMAGNETIC EMISSIONS.....	16
9.2 ELECTROMAGNETIC IMMUNITY	17
9.3 RECOMMENDED SAFE DISTANCES	18
9.4 TECHNICAL SPECIFICATIONS.....	19
10. ACCESSORIES AND SPARES	21
11. PACKAGING AND DISPOSAL INFORMATION.....	23

	Consult instructions for use		General warning sign
	Date of manufacture		Warning: Electricity
	Manufacturer's name and address		Warning: Floor level obstacle
	Country of manufacture		Warning: Non-ionizing radiation
	Waste Electrical and Electronic Equipment (WEEE) recycling		Warning: Optical radiation
	This way up		Warning: Hot surface
	Keep dry		Conformité Européenne
	Fragile		Type B applied part
	Do not use if package is damaged		Class II equipment
	Temperature limit		Atmospheric pressure limitation
	Authorised representative in the European Community		Humidity limitation
	Catalogue number		Serial number
	Translation		Medical device

The Tomey Slit Lamp is designed and built in conformity with Directive 93/42/EEC, Regulation (EU) 2017/745 and ISO 13485 Medical Devices Quality Management Systems.

Classification: CE: Class I

FDA: Class II

The information contained within this manual must not be reproduced in whole or part without the manufacturer's prior written approval. As part of our policy for continued product development we the manufacturer reserve the right to make changes to specifications and other information contained in this document without prior notice.

Copyright © Tomey GmbH 2021. Published in the UK 2021.

1. INDICATIONS FOR USE

This device is intended to be used only by suitably trained and authorised healthcare professionals.



CAUTION: Federal Law restricts this device to sale by or on the order of a physician or practitioner.

Intended use / purpose of instrument

This Tomey Slit Lamp is an AC-powered slit lamp biomicroscope and is intended for use in eye examination of the anterior eye segment, from the cornea epithelium to the posterior capsule. It is used to aid in the diagnosis of diseases or trauma which affects the structural properties of the anterior eye segment.

The Tomey Slit Lamp is an instrument consisting of a light source that can be focused to shine a thin sheet (slit) of light into the eye. It is used in conjunction with a biomicroscope. The lamp facilitates an examination of the anterior segment, or frontal structures and posterior segment, of the human eye, which includes the eyelid, sclera, conjunctiva, iris, natural crystalline lens, and cornea. The binocular Slit Lamp examination provides stereoscopic magnified view of the eye structures in detail, enabling anatomical diagnoses to be made for a variety of eye conditions.

Brief description of the instrument

This Tomey Slit Lamp can either be mounted onto a custom table top supplied by Tomey or can be mounted on a third parties table top (refraction unit) by suitably trained technicians.

The Tomey Slit Lamp consists of 5 assemblies; Illumination Tower; Observation System; XYZ Translation Base; Chinrest Assembly and a Table Top with power supply and accessory drawer.

The light intensity is controlled by a variable rheostat located on the XYZ Translation Base. There are a number of selectable filters allowing the user to control the characteristics of the examination light. Many ophthalmic instruments illuminate the eye with intense light. The light intensity on the Tomey Slit Lamp is continuously adjustable from maximum to zero.

2. SAFETY

2.1 PHOTOTOXICITY



CAUTION: The light emitted from this instrument is potentially hazardous. The longer the duration of exposure, the greater the risk of ocular damage. Exposure to light from this instrument when operated at maximum intensity will exceed the safety guideline after 81 seconds.



While no acute optical radiation hazards have been identified for slit lamps, we recommend keeping the intensity of the light reaching the patient's retina to the minimum possible for the respective diagnosis. Children, people with aphakia and people suffering from eye conditions are most at risk. An increased risk may also occur if the retina is exposed

to the same or a similar device with a visible light source within 24 hours. This applies, in particular, if the retina has been photographed with a flashbulb in advance.

Tomey GmbH shall on request, provide the user with a graph showing the relative spectral output of the instrument.

2.2 WARNINGS AND CAUTIONS

Please note that the proper and safe functioning of our instruments is only guaranteed if both the instruments and their accessories are exclusively from Tomey GmbH. The use of other accessories may result in increased electromagnetic emissions or reduced electromagnetic immunity of the device and may lead to incorrect operation.

Observe the following prescriptions in order to ensure safe operation of the instrument.



WARNINGS

- Never use the instrument if visibly damaged and periodically inspect it for signs of damage or misuse.
- Check your Tomey product for signs of transport / storage damage prior to use.
- Do not use in the presence of flammable gases / liquids, or in an oxygen rich environment.
- US Federal Law restricts this device to sale by or on the order of a physician or practitioner.
- This device is intended to be used only by suitably trained and authorised healthcare professionals.
- This product should not be immersed in fluid.
- Repairs and modifications to the instrument must be made only by the specialized technicians of the manufacturer's Technical Service Centre or by personnel trained and authorised by the manufacturer. The manufacturer declines any and all responsibility for loss and/or damages resulting from unauthorised repairs; furthermore, any such actions will invalidate the warranty.
- The power switch and mains plug are the means of isolating the device from the mains supply - ensure both the power switch and mains plug are accessible at all times.
- Do not position the equipment so that is difficult to press the power switch or remove the mains plug from the wall socket.
- Refraction stand variants or adaptors should only be used in combination with EN/IEC 60601-1 and EN/IEC 60601-1-2 compliant power supplies and devices.



- Route power cords safely to eliminate risk of tripping or damage to user.



- Before any cleaning of the instrument or the base unit ensure the power lead is disconnected.



- LEDs can reach high temperatures in use – allow to cool before handling.



- Do not exceed maximum recommended exposure time.
- Should the instrument suffer shocks (for example, should it accidentally fall), and the optical system or the illumination system are damaged it may be necessary to return the instrument to the manufacturer for repair.
- After removal of the LED, do not touch the Slit Lamp LED electrical contacts and patient simultaneously.
- The owner of the instrument is responsible for training personnel in its correct use.
- Ensure the instrument or instrument table is placed on a level and stable surface.
- Use only genuine Tomey approved parts and accessories or device safety and performance may be compromised.
- Shut down after every use. In case the dust cover is used: risk of overheating.
- For indoor use only (protect from moisture).
- Electrical equipment can be affected by electromagnetic interference. If this occurs whilst using this equipment, switch the unit off and reposition.
- Do not touch accessible connectors and the patient simultaneously.
- The Tomey Slit Lamp should not be used adjacent to or stacked with other equipment. If adjacent or stacked use with other equipment is necessary the Tomey Slit Lamp should be observed/monitored to verify normal operation in the configuration in which it will be used.
- The Tomey Slit Lamp cannot be used in the vicinity of sources known to cause electromagnetic disturbance (magnetic resonance imaging, computed tomography, radio-frequency identification, metal detectors, electronic article surveillance and other electromagnetic security systems). Do not bring the Tomey digital Slit lamp into magnetic resonance environment.



Before use, the Slit Lamp should be allowed to adjust to the ambient room temperature for several hours. This is especially important when the unit has been stored or transported in a cold environment; this can cause severe condensation to develop on the optical elements.

2.3 CONTRAINDICATION

There is no restriction to patient population this device can be used with other than those outlined in the contra-indications stated below.

Slit lamps can produce discomfort in some photophobic patients due to the high illumination. Additionally patients must be co-operative and capable of sitting upright for the duration of the examination, therefore the technique may not be suitable for patients who are unable to sit upright for long periods of time or those with limited neck and back mobility.

3. CLEANING AND DISINFECTION INSTRUCTIONS

 **Before any cleaning of the instrument or the base unit, ensure the power lead is disconnected.**

Only manual non-immersion cleaning as described should be used for this instrument. Do not autoclave or immerse in cleaning fluids. Always disconnect power supply from source before cleaning.

1. Wipe the external surface with a clean absorbent, non-shedding cloth dampened with de-ionised water / detergent solution (2% detergent by volume) or water / isopropyl alcohol solution (70% IPA by volume). Avoid optical surfaces.
2. Ensure that excess solution does not enter the instrument. Use caution to ensure cloth is not saturated with solution.
3. Surfaces must be carefully hand-dried using a clean non-shedding cloth.
4. Safely dispose of used cleaning materials.

4. NAMES OF CONTROLS AND COMPONENTS

Headrest Assembly

1. Fixation light cable
2. Forehead rest band
3. Patient's eye height marker
4. Fixation light
5. Chinrest
6. Chinrest height adjuster
7. Patient grab handles

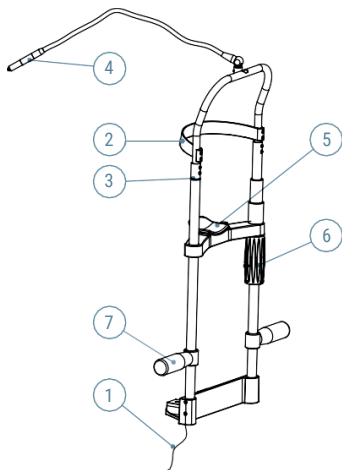

TOMEY SLIT LAMP, Z Series

8. Eyepiece assembly securing knob
9. Yellow filter knob (up = out)
10. Illumination prism
11. Slit offset by rotating prism housing
12. Filter control wheel
13. Slit rotation knob
14. Slit width control knob
15. Aperture control wheel
16. Test bar & tonometer plate hole and cover

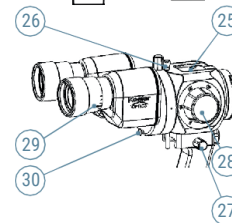
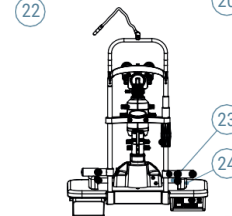
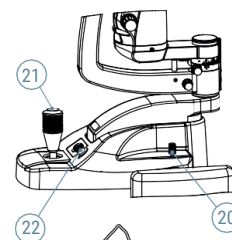
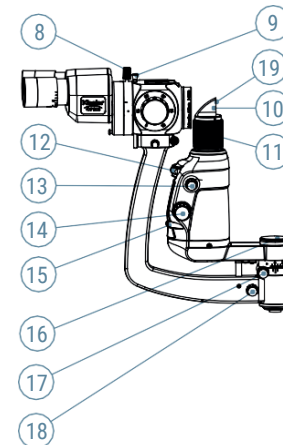

17. Illumination arm locking knob
18. Microscope arm locking knob
19. Diffuser
20. Joystick base locking knob
21. Joystick control (X Y Z movement)
22. Illumination control rheostat
23. Axle
24. Runner covers
25. Z type tonometer mounting hole
26. Yellow filter knob (up = out)
27. Lock for securing magnification body
28. Magnification change drum
29. Eyepieces – adjustable for PD and dioptre correction
30. Breath shield securing knob

31. Main power switch
32. Power supply unit
33. Glide plate

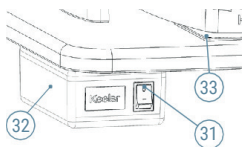

5. ASSEMBLY

Your Tomey Slit Lamp has been designed to fit on to an electric insulated medical table base or on to an electric insulated and fire resistant medical table top, e.g. a refraction stand or combi unit.

Take care when unpacking your Slit Lamp that you do not accidentally damage or discard any of the contents.

⚠ Leave the Slit Lamp in the packing for several hours after delivery before unpacking to reduce the risk of condensation forming.

Tomey Slit Lamps can be fitted to most Refraction Stands / Combi units. Tomey advises that this shall be carried out by a suitably trained technicians to ensure performance and safety are not affected.

⚠ The Refraction Stand, Combi Unit or table leg must be IEC 60601-1 compliant.

If you are fitting or have fitted your Slit Lamp to a medical or Tomey table leg / base ensure it is situated on a firm and level floor.

If the table leg / base has castors ensure the following before moving it to another location:

1. The table is at its lowest position.
2. The power cord is removed.
3. The Slit Lamp arm and base locking knobs are tightened.
4. The runner covers are securely located.
5. The system is moved by grasping it at its lowest practical point.

5.1 TABLE TOP AND BASE ASSEMBLY PROCEDURE

1. Attach the Slit Lamp table top to your table leg using the M6 x 20mm screws and washers. Note that the power supply and accessory drawer should face the operator.

⚠ The security of the fitment of the table top to the table leg is critical for patient and Slit Lamp safety

2. Using the wrench provided, fit the headrest assembly to the tabletop using the hex bolts and washers. The headrest assembly locates on the underside of the tabletop. Take care not to over tighten the hex bolts.
3. Attach the patient grab handles (7) to the headrest assembly.
4. Place the Slit Lamp base on the runners. Ensure that the wheels are in line with each other. Check that the guide wheels are tight.
5. Fit the runner covers to the runners by gently sliding them inwards, towards each other.

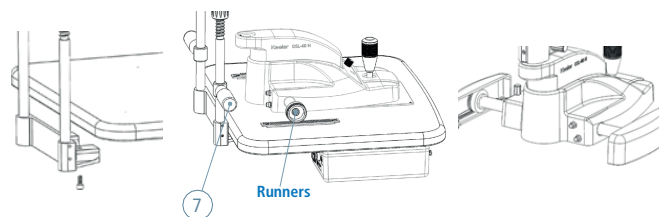

5.2 ILLUMINATION TOWER ASSEMBLY PROCEDURE

1. Remove the hex bolt (a) from the base of the Illumination Tower, and then place the Illumination Tower on the Slit Lamp base with the base notch (b) and pin (c) aligned. Attach the tower to the base using the hex bolt removed earlier and tighten using the wrench provided.

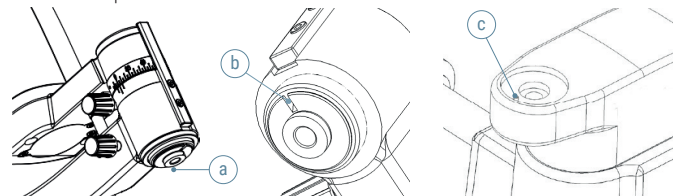

2. Carefully fit the microscope body to the arm – ensuring it is pushed to the stop. Tighten using the securing knob on the side.

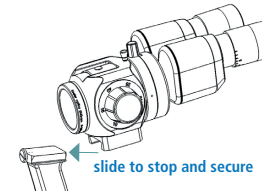

- Attach the breath shield as indicated in the images below.

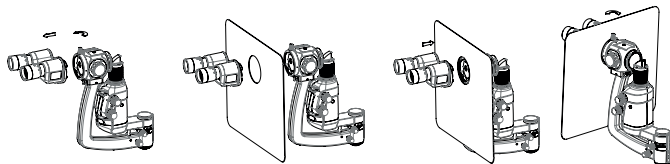

5.3 CABLE ATTACHMENT PROCEDURE

- Connect the power cables.
 - Chinrest fixation light cable to power supply unit.
 - (3 pin) cable from power supply unit to slit lamp base assembly.
 - (4 pin) main lamp cable from bottom of the illumination assembly to the slit lamp base assembly.
 - Ensure cables are routed to allow free movement of the XYZ base and to be clear of the patients.

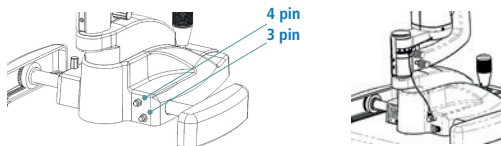

If your Slit Lamp was not supplied with a transformer (Part #3020-P-5040-TOM), make sure that the power connection is compatible with the specifications in this manual and is connected by a qualified technician to an available and suitable power supply, see section 9.4 Power Supply page 20.

- If the Tomey Slit Lamp is used with a power supply or cables other than those supplied, this may result in increased emissions or decreased immunity of the Tomey Slit Lamp in relation to EMC performance.
- Connect the mains power to the Slit Lamp transformer using the power lead provided.

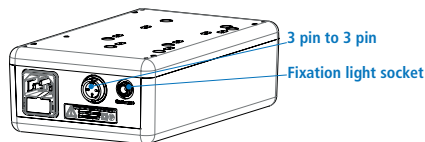

- To isolate from the mains supply unplug the mains plug from the wall socket. Ensure that the product is positioned so that it is easily accessible.



Only a hospital grade 3-conductor electrical power supply cable must be used. For USA and Canada: Detachable power supply cord set, UL listed, type SJE, SJT or SJO, 3-conductor, not smaller than 18 AWG. Plug, cable and ground lead connection of the socket have to be in perfect condition.

5.4 FITTING APPLANATION TONOMETERS, T TYPE AND R TYPES

Tomey Applanation Tonometer (T-TYPE)

- Position the guide plate in the tonometer / test bar support hole on the slit lamp.
- Lift Tonometer out of the packaging and assemble it by inserting the pin on its base into one of the two possible openings (for right or left eye) on the horizontal guide plate above the slit lamp axis. These positions are related to the microscope optics and observation can be made either through the right or the left eye-piece.

The tonometer will slip easily onto the support plate; stability is assured by the locking pins.

- To obtain an image as clear and as free of reflexes as possible, the angle between the illumination and the microscope should be about 60° and the slit diaphragm should be fully opened.
- When not in use the Tonometer should be removed from the Slit Lamp and placed securely back in the packaging or a suitable location.

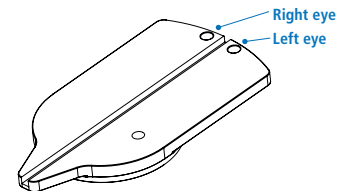

Applanation Tonometer 'Tomey Fixed' (R-TYPE)

This instrument is for those who wish the tonometer to remain permanently on the slit lamp.

- Mount the plate for the tonometer onto the microscope body using the securing screw.
- Mount the Tonometer onto the mounting post ensuring the grub screws are loose.
- Swing the Tonometer arm forward in front of the microscope for examination. Rotate the Tonometer body until the prism is in the centre of the view through the eyepiece. Carefully tighten the two retaining grub screws in turn until the Tonometer is secure on the mount and the prism is in the centre of view.
- To obtain an image as clear and as free of reflexes as possible, the angle between the illumination and the microscope should be about 60° and the slit diaphragm should be fully opened.
- When not in use the tonometer arm should be swung up against the protection plate.

6. INSTRUCTIONS FOR USE

6.1 SETTING THE BINOCULARS

! It is vital that the binoculars are optimised for the user's optical correction in order to obtain focused binocular images.

1. Remove the Test Bar locating hole cover plate (16) and place the test bar focus in the test bar location hole at the base of the microscope arm. To access the location hole first remove the cover. The test bar should be set with the flat projection face towards the Slit Lamp Microscope. The illumination and the microscope should be in the zero degrees position.
2. Turn on the Slit Lamp and set the slit to full width (14), set the magnification to x16 (27).
3. Adjust the eyepieces pupillary distance by holding both eyepiece bodies and rotating them inwards or outwards until they are correct for your PD.

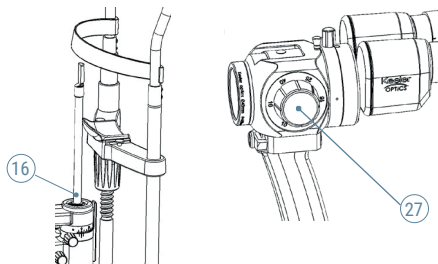

4. Turn both eyepieces (28) to maximum plus (+) correction.
5. Close one eye, and with the other eye look through the microscope slowly turning the open eye eyepiece towards the minus (-) position until the image of the test bar is in focus. Stop.
6. Repeat the above process for the other eyepiece.
7. Make a note of the positions of the eyepieces so that you can set them quickly if the Slit Lamp has been used by another clinician.
8. Note – younger examiners are recommended to compensate for their ability to accommodate by further adjusting the eyepieces by minus one (-1) or minus two (-2) dioptres.

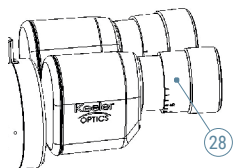

6.2 PREPARING THE PATIENT AND USING THE SLIT LAMP

! Parts of the slit lamp coming in to contact with the patient should be cleaned in accordance with these instructions prior to the examination. Tomey recommends the use of disposable hygienic chinrest tissues on the Chinrest before the patients place their chin on it.

Never use the instrument if visibly damaged and periodically inspect it for signs of damage or misuse.

1. The patient should be as comfortable as possible and with the patient in the chinrest adjust the chinrest height (6) so that the patient's eyes are level with the height marking (3) on the chinrest support.
2. Focus the eyepieces using the test bar as described earlier, and if you have not already done so set them to your interpupillary distance by holding both eyepiece bodies and rotating them inwards or outwards until they are correct for your PD.
3. Switch on the illumination, making sure the rheostat (21) is set to a low level to minimise the patient's exposure to light hazard.
4. Rotate the joystick (20) until the light beam is at eye level.
5. Holding the joystick vertical, move the slit Lamp base towards the patient until the slit beam appears focused on the patient's cornea.
6. Adjust slit width (14), magnification (27), slit rotation (13) and slit angle etc. as required to perform the examination.
7. To offset the slit for sclerotic scatter or retro illumination, rotate the illumination prism assembly (11) to the left or right as desired.
8. When using the blue filter (12) the user may wish to insert the yellow barrier filter (9). The yellow barrier filter is out when the knob is up, in when it is down.
9. When the examination is complete, set the rheostat to a low level and switch off the Slit Lamp.

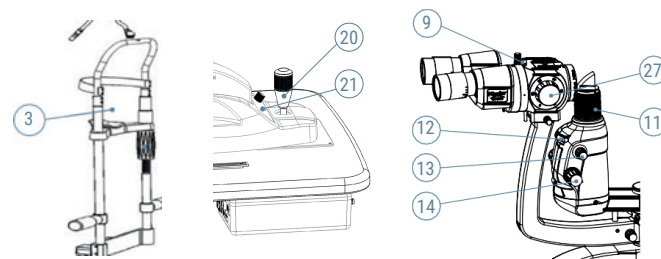

! Shut down after every use. In case the dust cover is used: risk of overheating.

6.3 DESCRIPTION OF FILTERS, APERTURES AND MAGNIFICATIONS

Stereo microscope

Eyeieces	12.5x
Dioptric adjustment	+/- 8D
PD range 8° converging eyeieces	49mm – 77mm
Convergent angle of optical axis	13°

Magnification change

5 step drum	3 step drum	Magnification	Field of view
3	5	6x	34mm
3	3	10x	22mm
3	3	16x	14mm
3	3	25x	8.5mm
3	5	40x	5.5mm

Filters

- Clear
- Neutral Density
- Red Free
- Blue

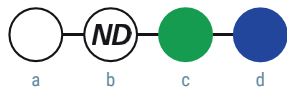

Apertures



Aperture diameters (mm)

Tower illumination

Tower has the facility to tilt towards the user and positively locates at each step. 0°, 5°, 10°, 15° and 20°.

7. ROUTINE MAINTENANCE



The maintenance outlined below should only be carried out once the main power cable has been disconnected. If you have any problems that are not covered by the procedures described below, contact Tomey GmbH or your local supplier.

7.1 LED SYSTEMS

- LED's typically have a life exceeding 10,000 hours of continuous use and therefore can be considered as a non-consumable item that will not require changing by a user.
- Whilst this is a significant life expectancy, we suggest that the Slit Lamp is always switched off between examinations to conserve energy and LED life.
- In the unlikely event of an LED failure please contact Tomey or your local distributor for guidance on the replacement procedure.

7.2 REGULARLY INSPECT THE DEVICE FOR DAMAGE OR DIRT

- Routinely clean as per section 3 on page 6 cleaning instructions.

7.3 CLEANING THE ILLUMINATION PRISM

- The prism should be cleaned with a soft, clean lens cloth.
- Care must be taken to keep the objective and the eyepiece lenses clean – use only soft, clean lens cloths to clean optical surfaces.

7.4 ELECTRICAL CONNECTIONS

- Routinely check all electrical connections, cables and connectors.

7.5 OPTICS

- The optics should be wiped clean of any loose dirt or debris with a suitable dust brush then cleaned with a soft dry lens cloth, washed linen or other non abrasive lens cleaning material.

7.6 AXLE AND MECHANICAL PARTS

If the Slit Lamp becomes hard to move on the glide plate, the plate should be cleaned with a lightly oiled cloth or silicon polish. The axle should be cleaned only with dry lint free cloths.

8. WARRANTY

The Tomey Z-Series Slit Lamps are guaranteed for two years against faulty workmanship materials or factory assembly. Warranty is on a Return To Base (RTB) basis at the cost of the customer and may be void if the Slit Lamp has not been regularly serviced.

The manufacturer's warranty and terms and conditions are detailed on the Tomey GmbH website.

The mirror, main illumination lamp and general 'wear and tear' are excluded from our standard warranty.



The manufacturer declines any and all responsibility and warranty coverage should the instrument be tampered with in any manner or should routine maintenance be omitted or performed in manners not in accordance with these manufacturer's instructions.

There are no user serviceable parts in this instrument. Any servicing or repairs should only be carried out by Tomey GmbH or by suitably trained and authorised distributors. Service manuals will be available to authorised Tomey service centres and Tomey trained service personnel.

9. SPECIFICATIONS AND ELECTRICAL RATINGS

The Tomey Slit Lamp is a medical electrical instrument. The instrument requires special care concerning electromagnetic compatibility (EMC). This Section describes its suitability in terms of electromagnetic compatibility of this instrument. When installing or using this instrument, please read carefully and observe what is described here.

Portable or mobile-type radio frequency communication units may have an adverse effect on this instrument, resulting in malfunctioning.

9.1 ELECTROMAGNETIC EMISSIONS

Guidance and manufacturer's declaration – electromagnetic emissions

The Tomey Slit Lamp is intended for use in the electromagnetic environment specified below. The customer or user should ensure that it is used in such an environment.

Emissions test	Compliance	Electromagnetic environment – guidance
RF emissions CISPR 11	Group 1	The Tomey Slit Lamp uses RF energy only for its internal function. Therefore, its RF emissions are very low and are not likely to cause any interference in nearby electronic equipment.
RF emissions CISPR 11	Class B	The Tomey Slit lamp is suitable for use in a professional healthcare facility environment. The Tomey Slit lamp is not intended for use in home environment.
Harmonic emissions IEC 61000-3-2	Class B	
Voltage fluctuations / flicker emissions IEC 61000-3-3	Complies	

9.2 ELECTROMAGNETIC IMMUNITY

Guidance and manufacturer's declaration – electromagnetic immunity

The Tomey Slit Lamp is intended for use in the electromagnetic environment specified below. The customer or user should ensure that it is used in such an environment.

Immunity test	IEC 60601 Test level	Compliance level	Electromagnetic environment – guidance
Electrostatic discharge (ESD). IEC 61000-4-2	± 8 kV contact ± 15 kV air	± 8 kV contact ± 15 kV air	Floors should be wood, concrete or ceramic tile. If floors are covered with synthetic material, the relative humidity should be at least 30%
Electrical fast transient/burst. IEC 61000-4-4	± 2 kV for power supply lines ± 1 kV for power supply lines	± 2 kV for power supply lines N/A	Mains power quality should be that of a typical professional healthcare facility
Surge. IEC 61000-4-5	± 1 kV line(s) to line(s) ± 2 kV line(s) for input/output line(s)	± 1 kV line(s) to line(s) ± 2 kV line(s) for input/output line(s)	Mains power quality should be that of a typical professional healthcare facility
Voltage dips, short interruptions and voltage variations on power supply input lines. IEC 61000-4-11	$U_T = 0\%$ 0.5 cycle (0, 45, 90, 135, 180, 225, 270, 315°) $U_T = 0\%$; 1 cycle $U_T = 70\%$; 25/30 cycles (@ 0°) $U_T = 0\%$; 250/300 cycle	$U_T = 0\%$ 0.5 cycle (0, 45, 90, 135, 180, 225, 270, 315°) $U_T = 0\%$; 1 cycle $U_T = 70\%$; 25/30 cycles (@ 0°) $U_T = 0\%$; 250/300 cycle	Mains power quality should be that of a typical professional healthcare facility environment. If the user of the Tomey Slit Lamp requires continued operations during power mains interruptions, it is recommended that the instrument be powered from an uninterruptible power supply.
Power frequency (50/60 Hz) Magnetic field. IEC 61000-4-8	30 A/m	30 A/m	Power frequency magnetic fields should be at a level characteristic of a typical location in a typical professional healthcare facility environment.

Note: U_T is the a. c. mains voltage prior to application of the test level.

Immunity test	IEC 60601 Test level	Compliance level	Electromagnetic environment – guidance
			Portable and mobile RF communications equipment should be used no closer to any part of the Tomey Slit Lamp, including cables, than the recommended separation distances calculated from the equation applicable to the frequency of the transmitter.
Recommended separation distance			
Conducted RF IEC 61000-4-6	6 Vrms 150kHz to 80MHz	6 V	$d = 1.2 \sqrt{p}$
Radiated RF IEC 61000-4-3	10 V/m 150kHz to 280MHz	10 V/m	$d = 1.2 \sqrt{p}$ 80MHz to 800 MHz $d = 2.3 \sqrt{p}$ 800MHz to 2.7GHz
			Where p is the maximum output power rating of the transmitter in watts (W) according to the transmitter manufacturer and d is the recommended separation distance in metres (m). Field strengths from fixed RF transmitters, as determined by an electromagnetic site survey ¹ , should be less than the compliance level in each frequency range. ²  Interference may occur in the vicinity of equipment marked with this symbol.

Note: At 80MHz and 800MHz, the higher frequency range applies. These guide lines may not apply in all situations. Electromagnetic propagation is affected by absorption and reflection from structures, objects and people.

¹ Field strengths from fixed transmitters, such as base stations (cellular / cordless) telephones and land mobile radios, amateur radio, AM and FM radio broadcast and TV broadcast cannot be predicted theoretically with accuracy. To assess the electromagnetic environment due to fixed RF transmitters, an electromagnetic site survey should be considered. If the measured field strength in the location in which the Tomey Slit Lamp is used exceeds the applicable RF compliance level above, the Tomey Slit Lamp should be observed to verify normal operation. If abnormal performance is observed, additional measures may be necessary, such as re-orientating or relocating the Tomey Slit Lamp.

² Over the frequency range 150kHz to 80 MHz, field strengths should be less than 10 V/m.

9.3 RECOMMENDED SAFE DISTANCES

Recommended separation distances between portable and mobile RF communications equipment and the Tomey Slit Lamp

The Tomey Slit Lamp is intended for the use in an electromagnetic environment in which radiated RF disturbances are controlled. The customer or the user of the Tomey Slit Lamp can help prevent electromagnetic interference by maintaining a minimum distance between mobile RF communications equipment (transmitters) and the Tomey Slit Lamp as recommended below, according to the maximum output power of the communications equipment.

Rated maximum output power of transmitter (W)	Separation distance according to frequency of transmitter (m)		
	150 kHz to 80MHz $d = 1.2\sqrt{p}$	80MHz to 800MHz $d = 1.2\sqrt{p}$	800MHz to 2.7GHz $d = 2.3\sqrt{p}$
0.01	0.12	0.12	0.23
0.1	0.38	0.38	0.73
1	1.2	1.2	2.3
10	3.8	3.8	7.3
100	12	12	23

For transmitters rated at a maximum output power not listed above, the recommended separation distance d in metres (m) can be determined using the equation applicable to the frequency of the transmitter, where p is the maximum output power rating of the transmitter in watts (W) according to the transmitter manufacturer.

Note: At 80MHz and 800MHz, the separation distance for the higher frequency applies.

These guidelines may not apply in all situations. Electromagnetic propagation is affected by absorption and reflection from structures, objects and people.

9.4 TECHNICAL SPECIFICATIONS

Optical System

Binoculars type	Galilean 8° converging Galilean 0° parallel
Magnification	Drum change x6, x10, x16, x25 & x40 x10, x16 & x25
Eyepiece	x12.5
Field of view	34, 22, 14, 8.5 and 5.5 mm 22, 14 & 8.5mm
PD range	8° converging eyepieces, 49 – 77mm 0° parallel eyepieces, 38 – 85mm
Objective lens focal distance	107mm
Objective lens convergence angle	13°

Slit Projection System & Base

Slit Width	0-14mm continuously variable
Slit Length	14mm
Aperture diameters	0.2, 1mm square, 2, 3, 5, 9, 14 and reserved
Filters	Clear; red free; neutral density; blue;
Slit rotation	360° continuous, detents at 0° and 180°
Base travel	25mm Z-axis, 107mm X-axis, 110mm Y axis
Horizontal fine adjustment	12mm

Table top dimensions	405 x 500mm
Fixation lamp	LED
Light source	LED
LED output power	240Klux (+/-20%)

Weight, packed (approx.)

Slit Lamp complete	25Kg, 90 x 58 x 45cm W x D x H
---------------------------	--------------------------------

Protection against ingress IPx0**Class II ME equipment**

Insulation between mains parts and the functional earth provide at least two means of protection.

Power Supply

Power supply unit	Switch mode, (100V-240V input) +/- 10% multi plug compliant to EN/IEC 60601-1 EN/IEC 61000-6-2, EN/IEC 61000-6-3
Fuse	T2.5AH, 250V
Power supply output	12V DC: 2.5 amps must be EN/IEC 60601 compliant
Complies with	Electrical Safety (Medical) EN/IEC 60601-1 Electromagnetic compatibility EN/IEC 60601-1-2 Ophthalmic instruments - Fundamental requirements and test methods ISO 15004-1 Ophthalmic instruments - Optical radiation hazard ISO 15004-2

When the Slit Lamp is connected to the power supply together they constitute a Medical Electrical System as defined in EN/IEC 60601-1:2006.

The power supply forms a part of ME equipment.

Fuse Ratings and Quantity

2.5 amp anti-surge

Fuse current 2.5A







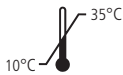

Voltage rating V AC 250V

Breaking capacity 1500Amps

Blow characteristic: Time Delay

Environmental Conditions:

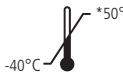
USE

			
	Shock (without packing)		10 g, duration 6 ms
STORAGE CONDITIONS			
			
TRANSPORT CONDITIONS			
			
	Vibration, sinusoidal		10 Hz to 500 Hz: 0.5g
	Shock		30 g, duration 6 ms
	Bump		10 g, duration 6 ms

*This instrument does not meet the temperature requirements of ISO 15004-1 for storage and transportation. Do not store or transport this instrument in conditions where the temperature may rise above 50 °C.

10. ACCESSORIES AND SPARES

Item	Part Number
DSL Digital Background Illum.Assy	3020-P-5039
Tomey PSU 12V	3020-P-5040-TOM
DSL Accessory Kit Packaging	3020-P-5221
DSL Screw Kit	3020-P-5240
Refraction Cable (XY-Bulb)	3020-P-7013
DSL Refraction Stand Cable Kit	3020-P-7014
DSL Digital Backlight Filters	3020-P-7054
1m DSL to PSU Cable	3020-P-7068
Tomey user instruction USB	3020-P-7069

Item	Part Number
Digital Base to Computer Cable	3020-P-7077
Fixation&llum to 6 Pin Connector	3020-P-7117
Dust Cover - No branding	EP39-19072
XY Pad (405)	EP39-80169
Linear Gear Rack (405)	EP39-80173
Linear Gear Rack Cover/silver	EP39-80174
DSL Test/Setting Bar	EP39-80243
DSL Illum Projection Mirror-Small	EP39-80250
Chin Rest Pins (406)	EP39-80321
DSL Table Template	EP39-80324
Cable Clip	EP39-80329
DSL DIGITAL X-Y PAD	EP39-80364
DSL DIGITAL LEFT/RIGHT LABEL	EP39-80365
1.27mm A/F ALLEN KEY	EP79-00766
5mm L-Shaped Hexagonal Key	EP79-10892
6mm L-Shaped Hexagonal Key	EP79-10905
Black Patient Handle	EP79-80070

11. PACKAGING AND DISPOSAL INFORMATION

(Applicable in the European Union and other European Countries with separate Collection Systems).

Disposal of old electrical and electronic equipment



This symbol on the product or on its packaging and instructions indicates that this product shall not be treated as household waste.

To reduce the environmental impact of WEEE (Waste Electrical Electronic Equipment) and minimise the volume of WEEE entering landfills we encourage at product end of life that this equipment is recycled and reused.

If you need more information on the collection reuse and recycling then please contact B2B Compliance on 01691 676124 (+44 1691 676124). (UK only). Any serious incident that has occurred in relation to the device must be reported to the manufacturer and the competent authority of your Member State.

Contact



Manufacturer

Keeler Limited
Clewer Hill Road



Windsor
Berkshire
SL4 4AA UK

Freephone 0800 521251

Tel +44 (0) 1753 857177

Fax +44 (0) 1753 827145

SUPPLIER

TOMEY GmbH
Wiesbadener Straße 21
90427 Nürnberg
Germany

Tel +49 911 938 546 2 - 0

Fax +49 911 938 546 2 - 20



Visiometrics, S. L., Vinyals, 131
08221 Terrassa, Spain

EP59-51500 Issue 5

Date of Issue 12/05/2021

